

SOLVERE CHKD BY: AS TITLE: DEUTSCHE BEVERAGE CO.
 69 McAdenville Road, Belmont, NC 28012
 Phone (704) 829-1015 • Fax (704) 829-1055

FILE NAME: S08293-50.dwg DATE ISSUED: 04/29/2015 SCALE: N.T.S. DRAWING NUMBER: S08293-50 REV: 0 SHEET: 50

DO NOT SCALE DRAWING

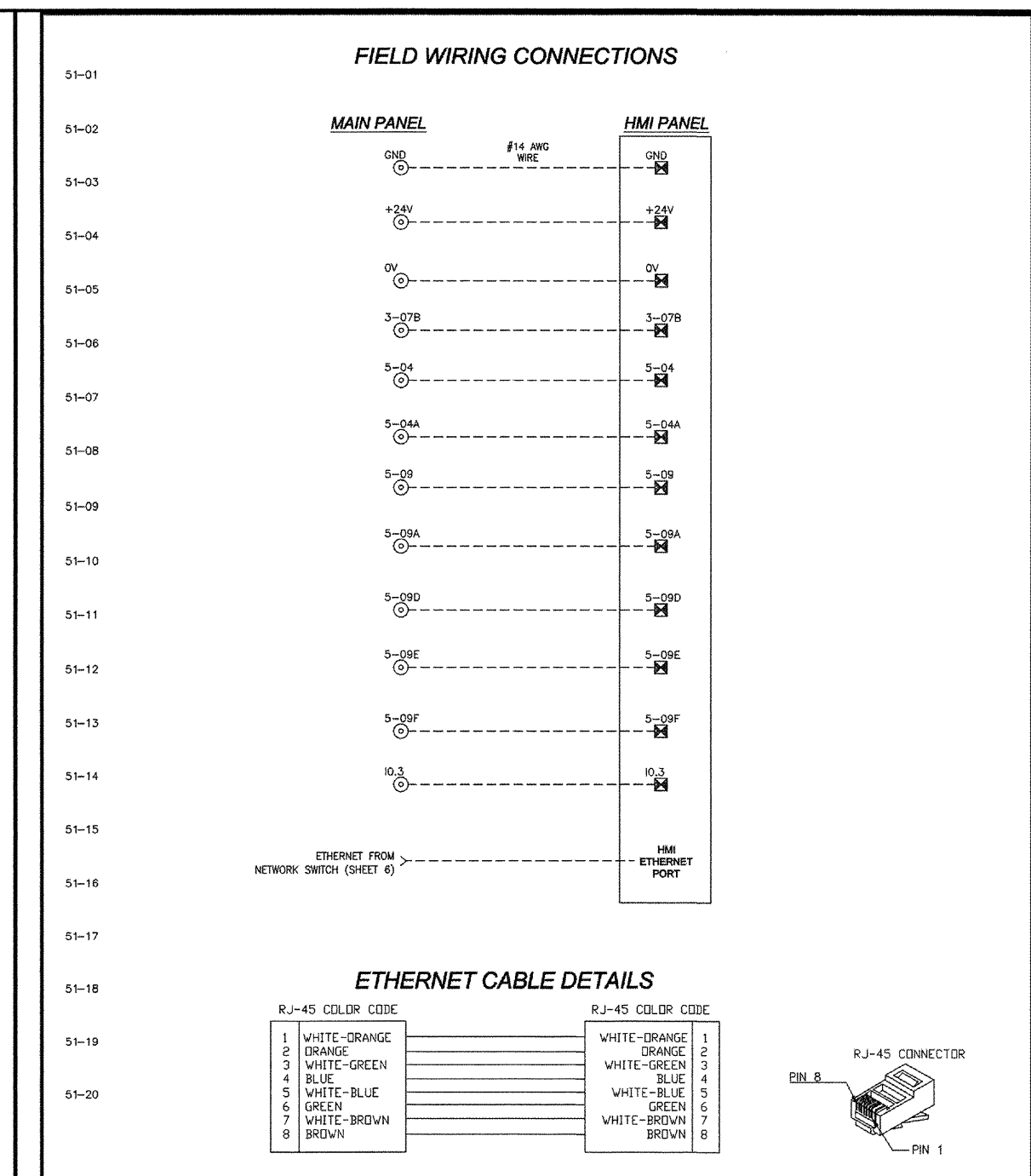

SOLVERE CHKD BY: AS TITLE: DEUTSCHE BEVERAGE CO.
 69 McAdenville Road, Belmont, NC 28012
 Phone (704) 829-1015 • Fax (704) 829-1055

FILE NAME: S08293-51.dwg DATE ISSUED: 04/29/2015 SCALE: N.T.S. DRAWING NUMBER: S08293-51 REV: 0 SHEET: 51

DO NOT SCALE DRAWING

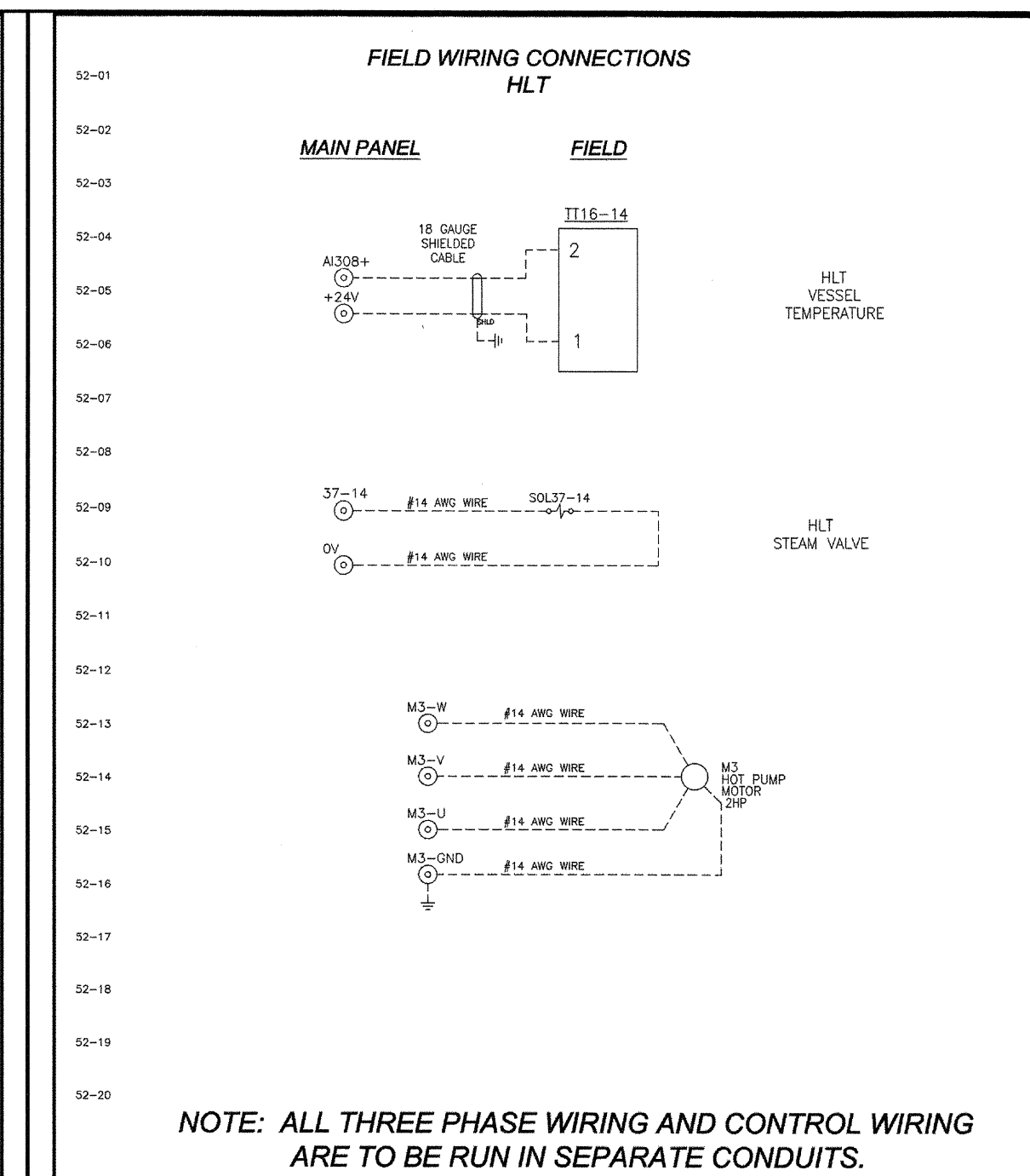

SOLVERE CHKD BY: AS TITLE: DEUTSCHE BEVERAGE CO.
 69 McAdenville Road, Belmont, NC 28012
 Phone (704) 829-1015 • Fax (704) 829-1055

FILE NAME: S08293-52.dwg DATE ISSUED: 04/29/2015 SCALE: N.T.S. DRAWING NUMBER: S08293-52 REV: 0 SHEET: 52

DO NOT SCALE DRAWING

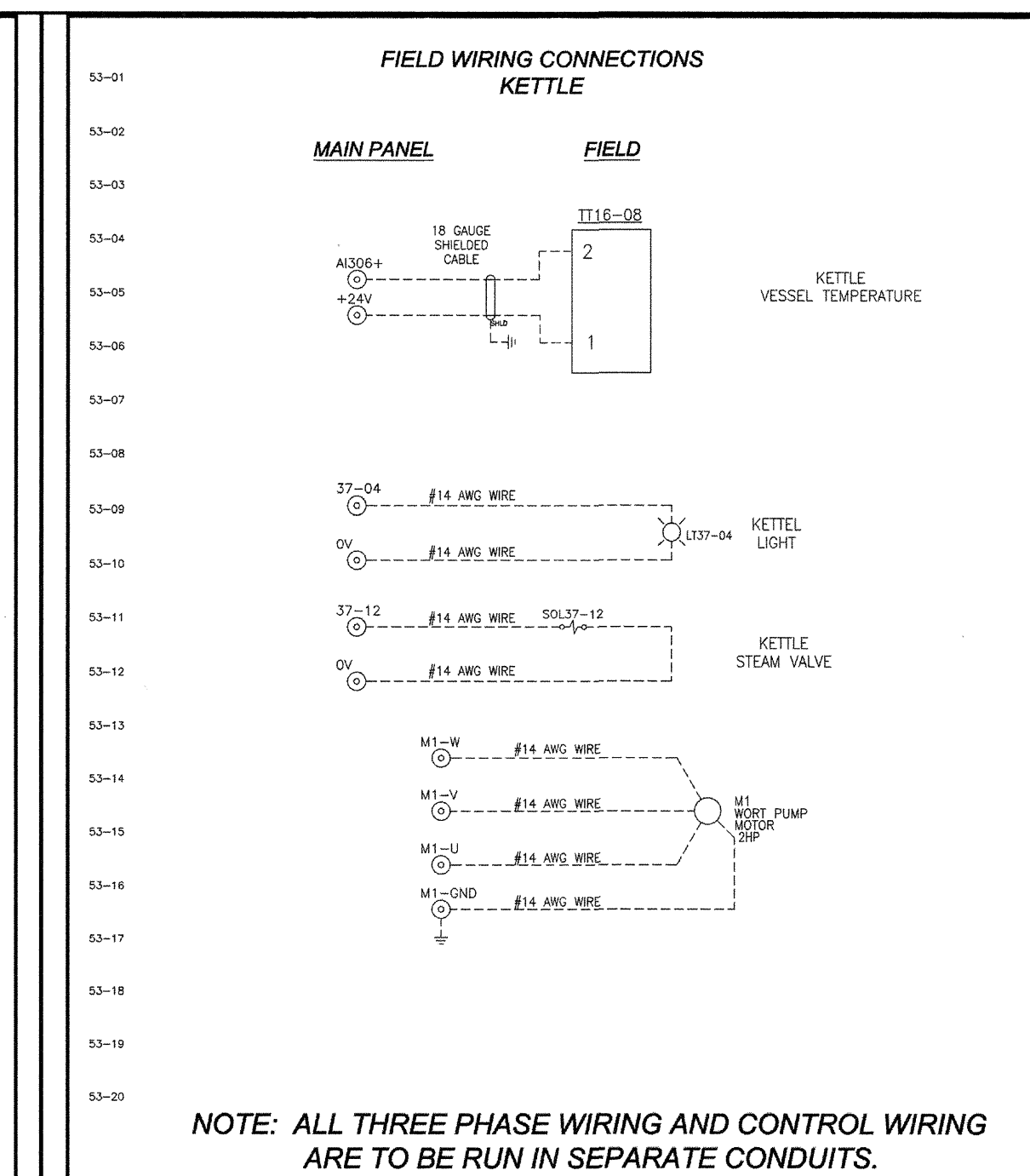

SOLVERE CHKD BY: AS TITLE: DEUTSCHE BEVERAGE CO.
 69 McAdenville Road, Belmont, NC 28012
 Phone (704) 829-1015 • Fax (704) 829-1055

FILE NAME: S08293-53.dwg DATE ISSUED: 04/29/2015 SCALE: N.T.S. DRAWING NUMBER: S08293-53 REV: 0 SHEET: 53

DO NOT SCALE DRAWING

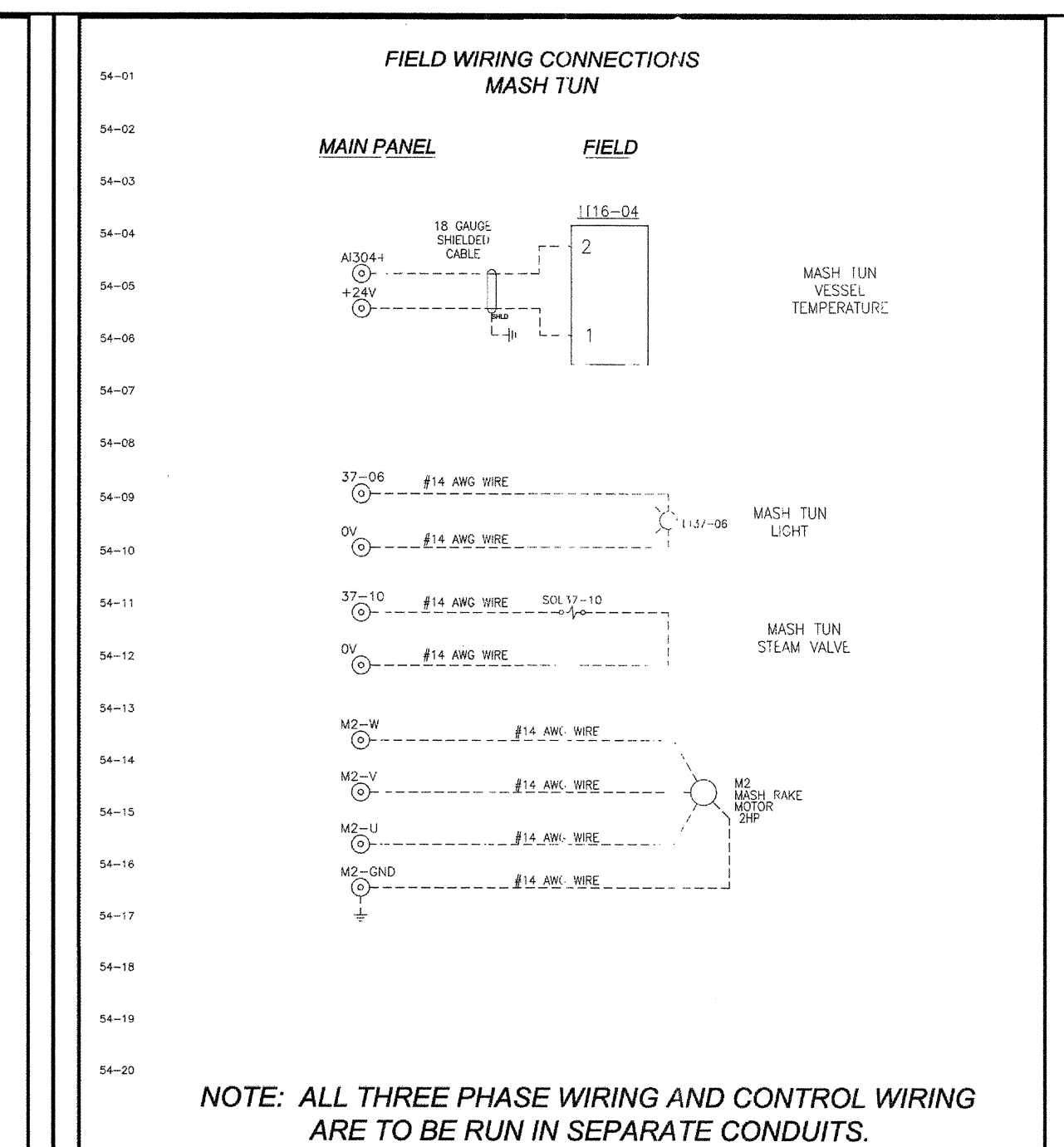

SOLVERE CHKD BY: AS TITLE: DEUTSCHE BEVERAGE CO.
 69 McAdenville Road, Belmont, NC 28012
 Phone (704) 829-1015 • Fax (704) 829-1055

FILE NAME: S08293-54.dwg DATE ISSUED: 04/29/2015 SCALE: N.T.S. DRAWING NUMBER: S08293-54 REV: 0 SHEET: 54

DO NOT SCALE DRAWING

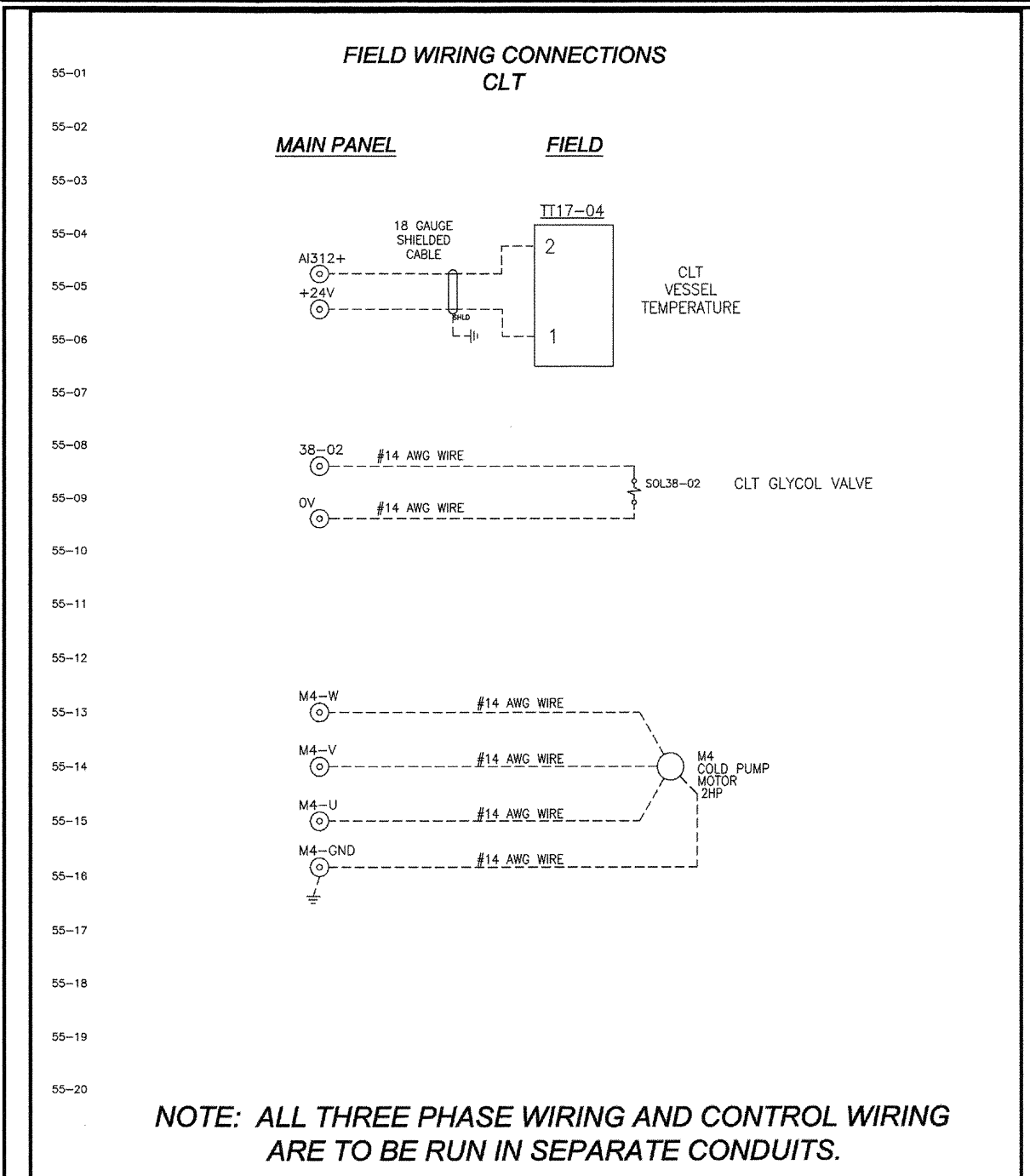

SOLVERE CHKD BY: AS TITLE: DEUTSCHE BEVERAGE CO.
 69 McAdenville Road, Belmont, NC 28012
 Phone (704) 829-1015 • Fax (704) 829-1055

FILE NAME: S08293-55.dwg DATE ISSUED: 04/29/2015 SCALE: N.T.S. DRAWING NUMBER: S08293-55 REV: 0 SHEET: 55

DO NOT SCALE DRAWING

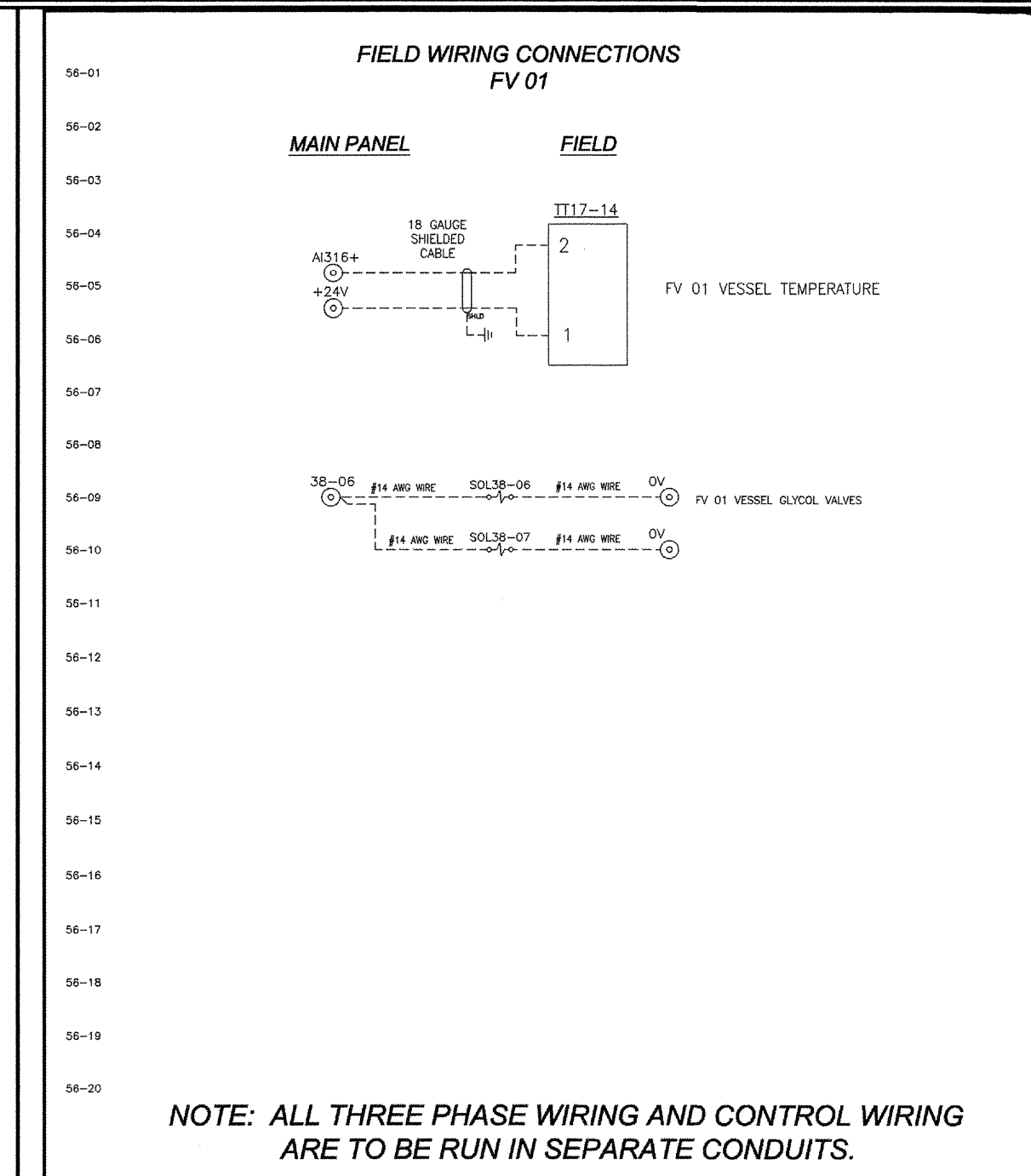

SOLVERE CHKD BY: AS TITLE: DEUTSCHE BEVERAGE CO.
 69 McAdenville Road, Belmont, NC 28012
 Phone (704) 829-1015 • Fax (704) 829-1055

FILE NAME: S08293-56.dwg DATE ISSUED: 04/29/2015 SCALE: N.T.S. DRAWING NUMBER: S08293-56 REV: 0 SHEET: 56

DO NOT SCALE DRAWING

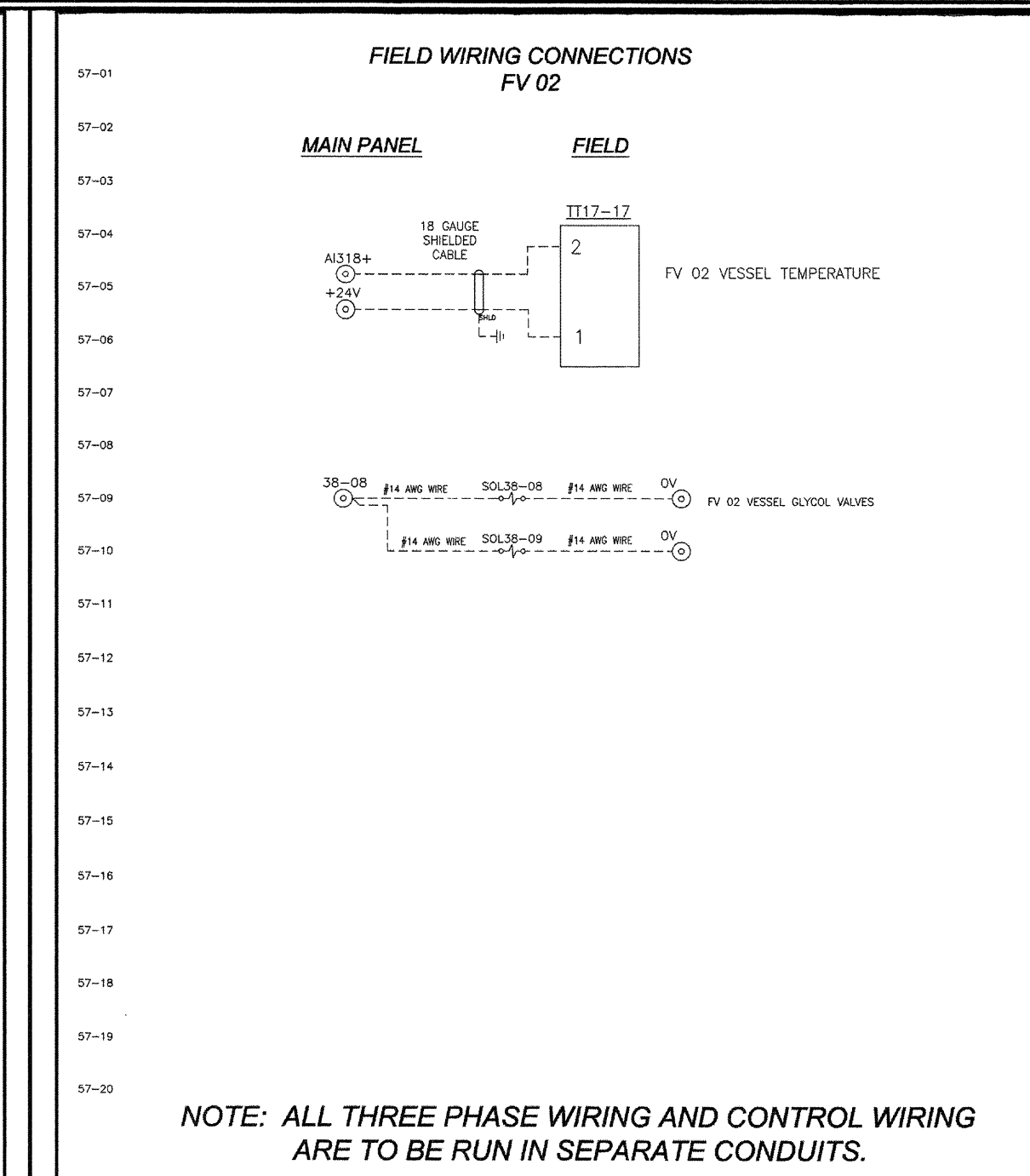

SOLVERE CHKD BY: AS TITLE: DEUTSCHE BEVERAGE CO.
 69 McAdenville Road, Belmont, NC 28012
 Phone (704) 829-1015 • Fax (704) 829-1055

FILE NAME: S08293-57.dwg DATE ISSUED: 04/29/2015 SCALE: N.T.S. DRAWING NUMBER: S08293-57 REV: 0 SHEET: 57

DO NOT SCALE DRAWING

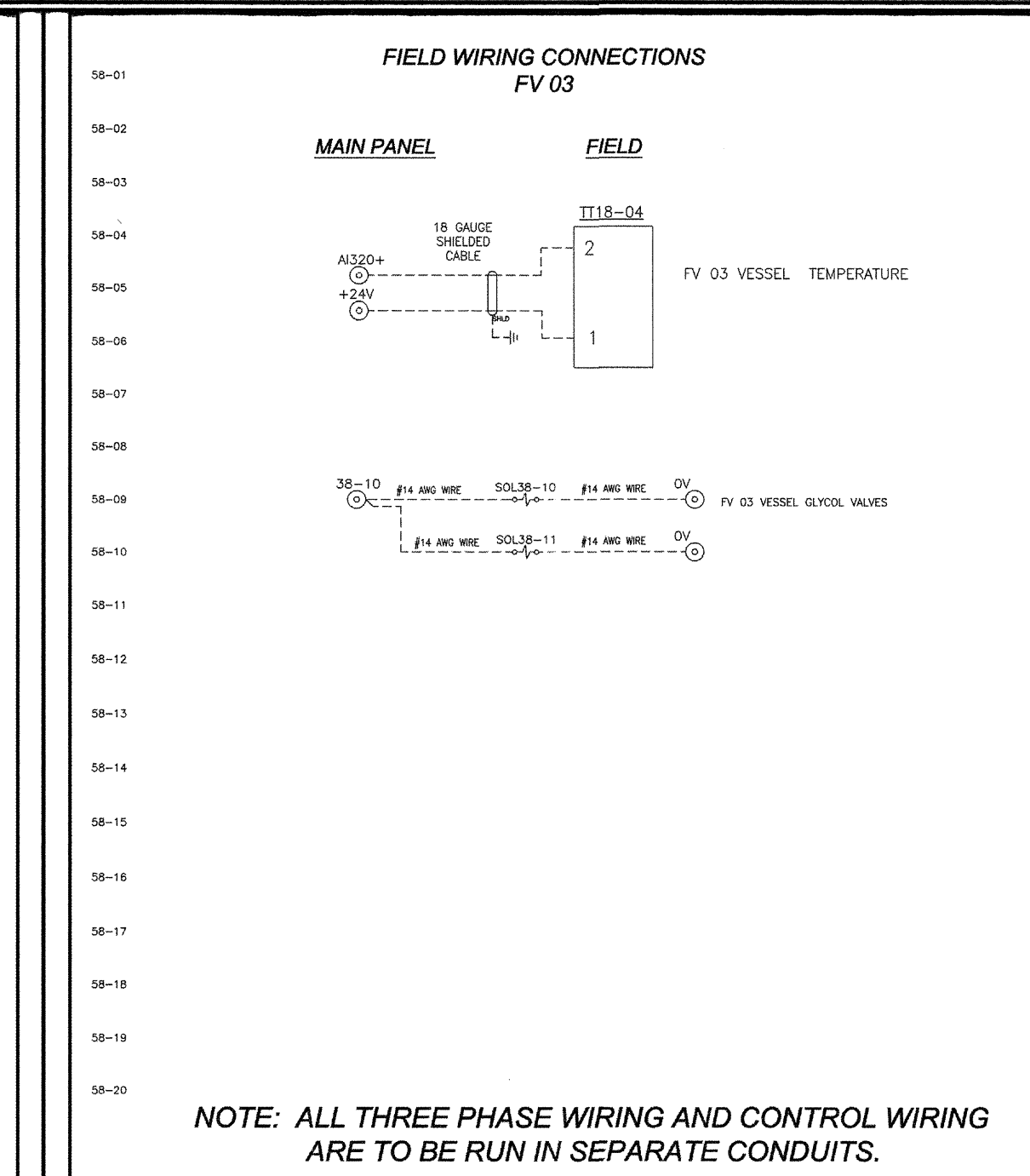

SOLVERE CHKD BY: AS TITLE: DEUTSCHE BEVERAGE CO.
 69 McAdenville Road, Belmont, NC 28012
 Phone (704) 829-1015 • Fax (704) 829-1055

FILE NAME: S08293-58.dwg DATE ISSUED: 04/29/2015 SCALE: N.T.S. DRAWING NUMBER: S08293-58 REV: 0 SHEET: 58

DO NOT SCALE DRAWING

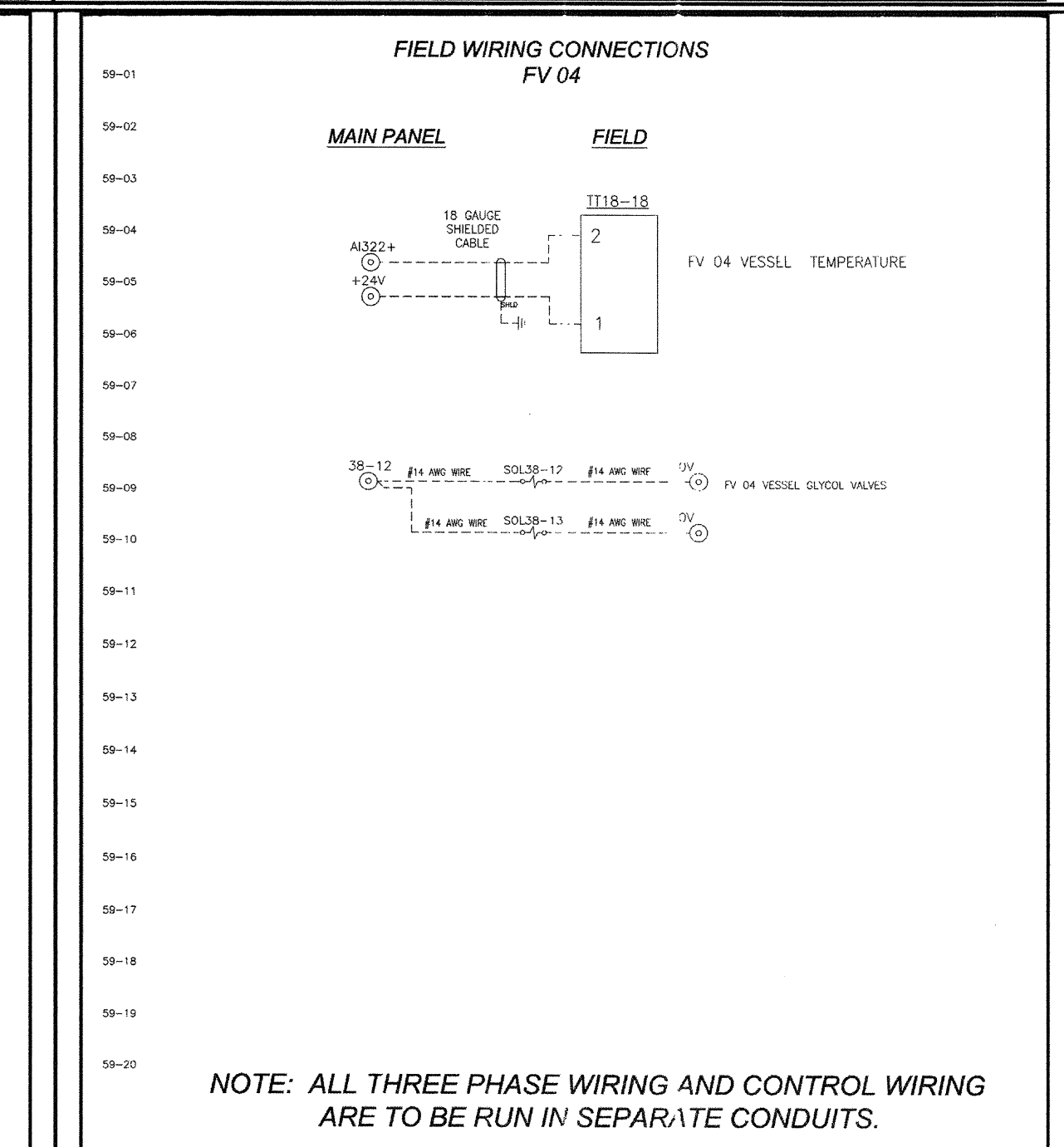

SOLVERE CHKD BY: AS TITLE: DEUTSCHE BEVERAGE CO.
 69 McAdenville Road, Belmont, NC 28012
 Phone (704) 829-1015 • Fax (704) 829-1055

FILE NAME: S08293-59.dwg DATE ISSUED: 04/29/2015 SCALE: N.T.S. DRAWING NUMBER: S08293-59 REV: 0 SHEET: 59

DO NOT SCALE DRAWING

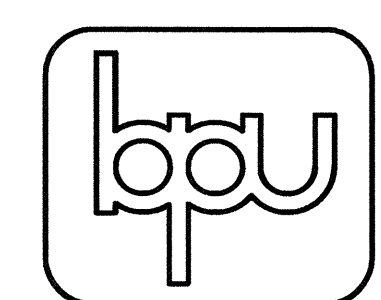
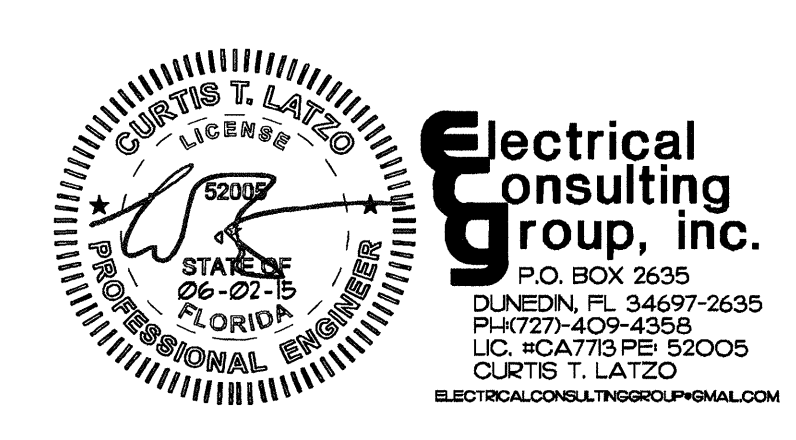

COMMERCIAL RENOVATIONS for DEBINE BREWERY
 999 Florida Av.
 PALM HARBOR, FL.

BARRY P. ULLMANN ARCHITECT, LLC
 615 S. MISSOURI AVE., SUITE B 727-441-4405
 CLEARWATER, FLORIDA 33756

REVISIONS	DATE

JOB NO. 201501	DRAWN BY WJI	CHECKED BY CTL	DATE 04/29/15	SHEET NO. 50	E-3